

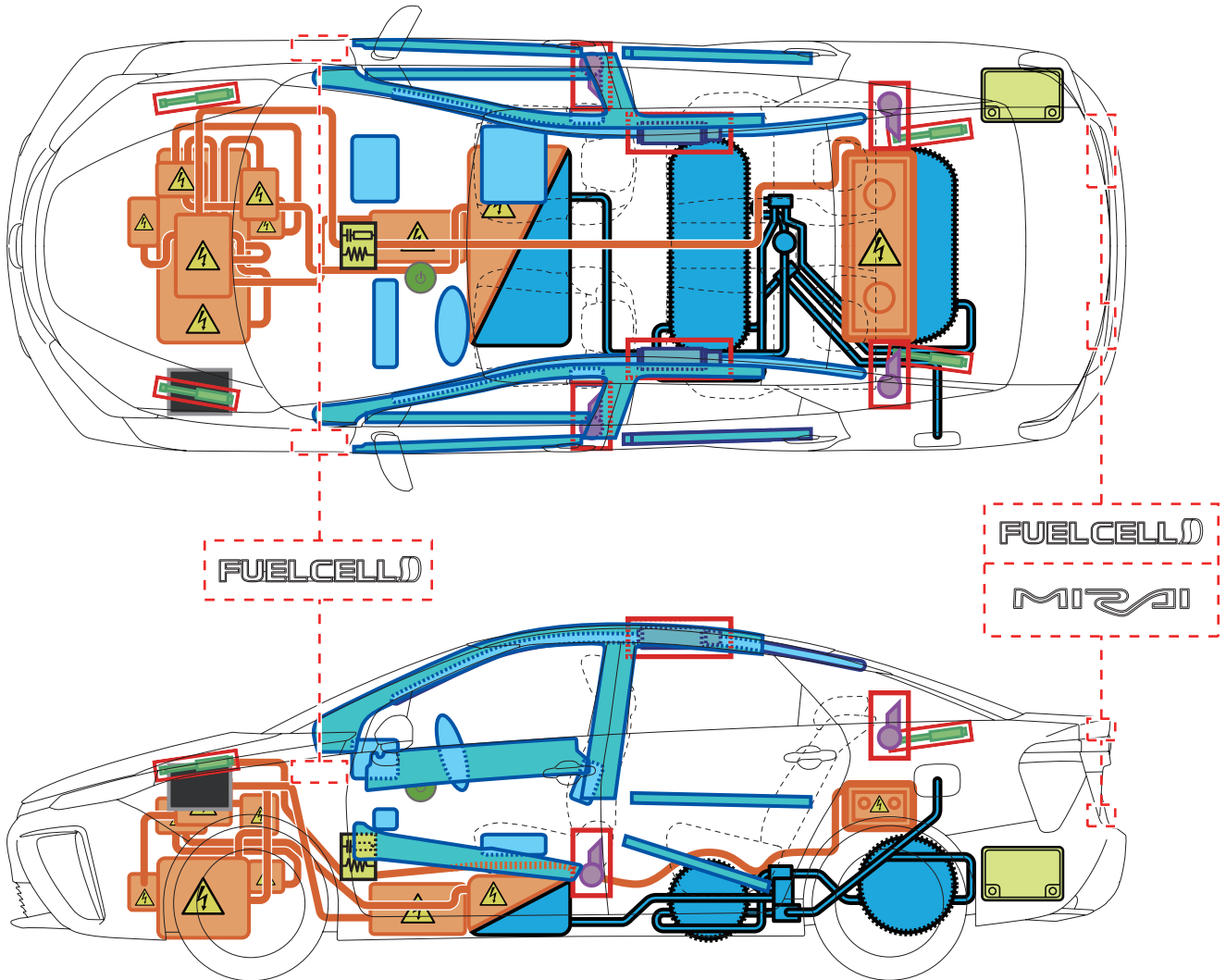













Toyota Mirai (AD1 (EU, M) 06 2015)



Legende

	Zündschalter		Sicherungs- kasten		12 Volt- Batterie
	Airbag		Gas- generator		Hochvolt- Batterie
	Hochvolt- bauteile		Hydrogen- tank		Hydrogen- komponenten
	Gasdruck- dämpfer		Gurtstraffer		Karosserie- verstärkung
	Steuergerät				

A

(Toyota Mirai AD1 (EU, M) 06 2015)

Toyota Mirai (AD1 (EU, M) 06 2015)



12V Spannungsversorgung trennen

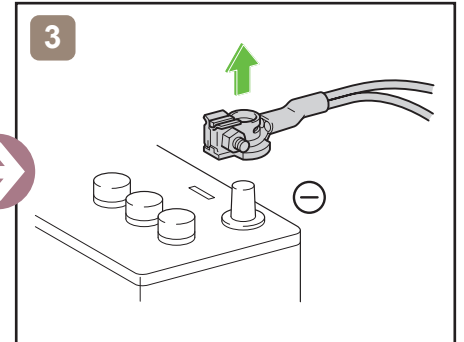
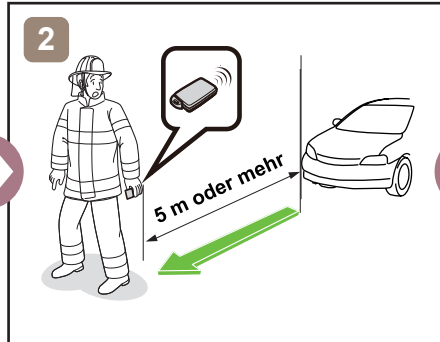
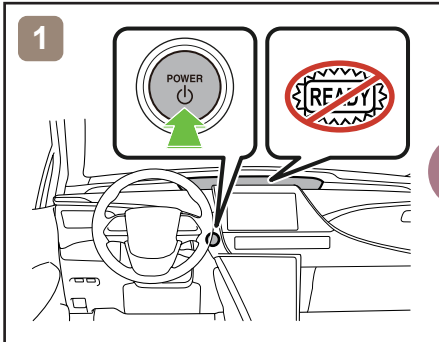

oder

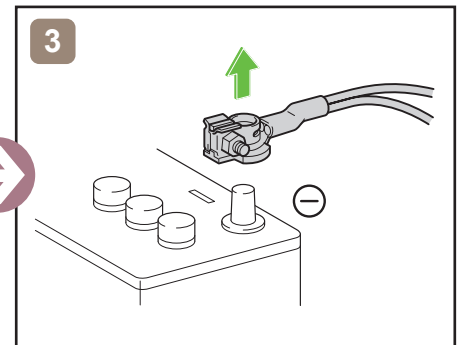
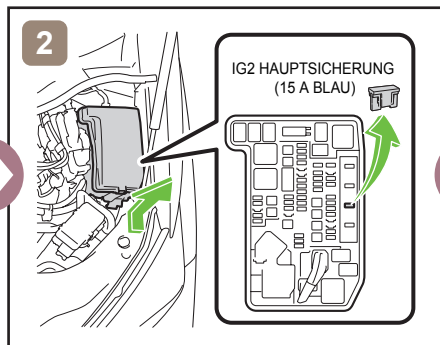
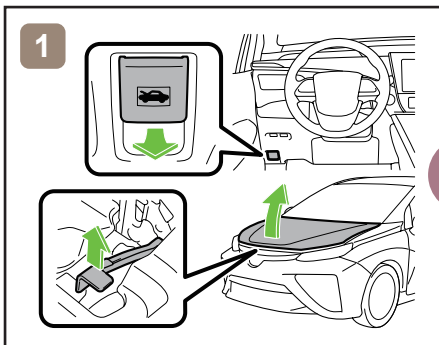

Zugang 12V Batterie

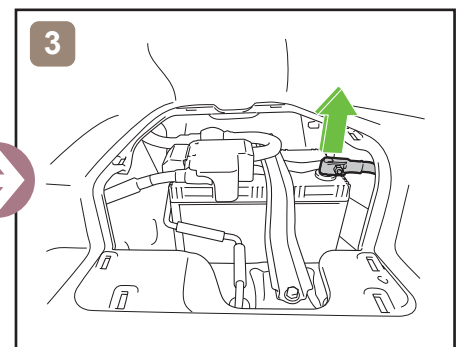
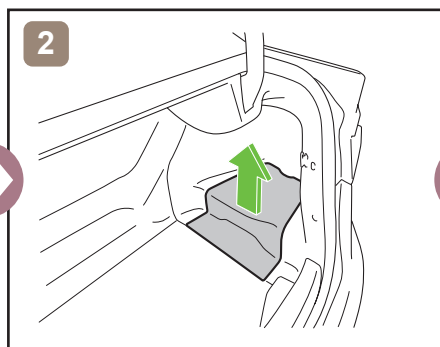
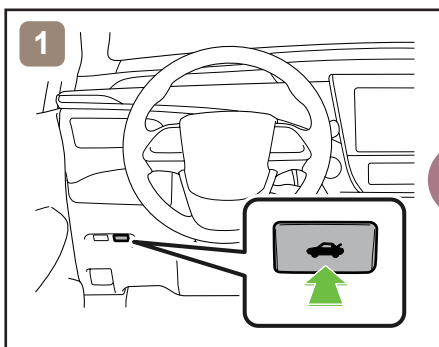

Hinweise zum Transport

